

Dekton®

Rev.07 - 05/2026

NOVY®

UNDERCOVER
INDUCTION

PRODUCT CONTENT



Index

Design Criteria	4
Basic concepts of the system	4
Available Novy invisible induction hobs	5
Panoramic configuration	6
Color code for system operation	7
Installation Criteria	8
Support and reinforcement	8
Recommended edges	9
Cut-outs: Sink and tap	10
Island overhangs: Area with induction hobs	12
Island overhangs: Area with cut-outs and/or drills	14
Waterfall edges	16
Other Considerations	18
Installation process and recommendations	20
Best practices	22
System usage	22
Cleaning and maintenance	24
Health and safety	26

Design Criteria

Basic Concepts of the System

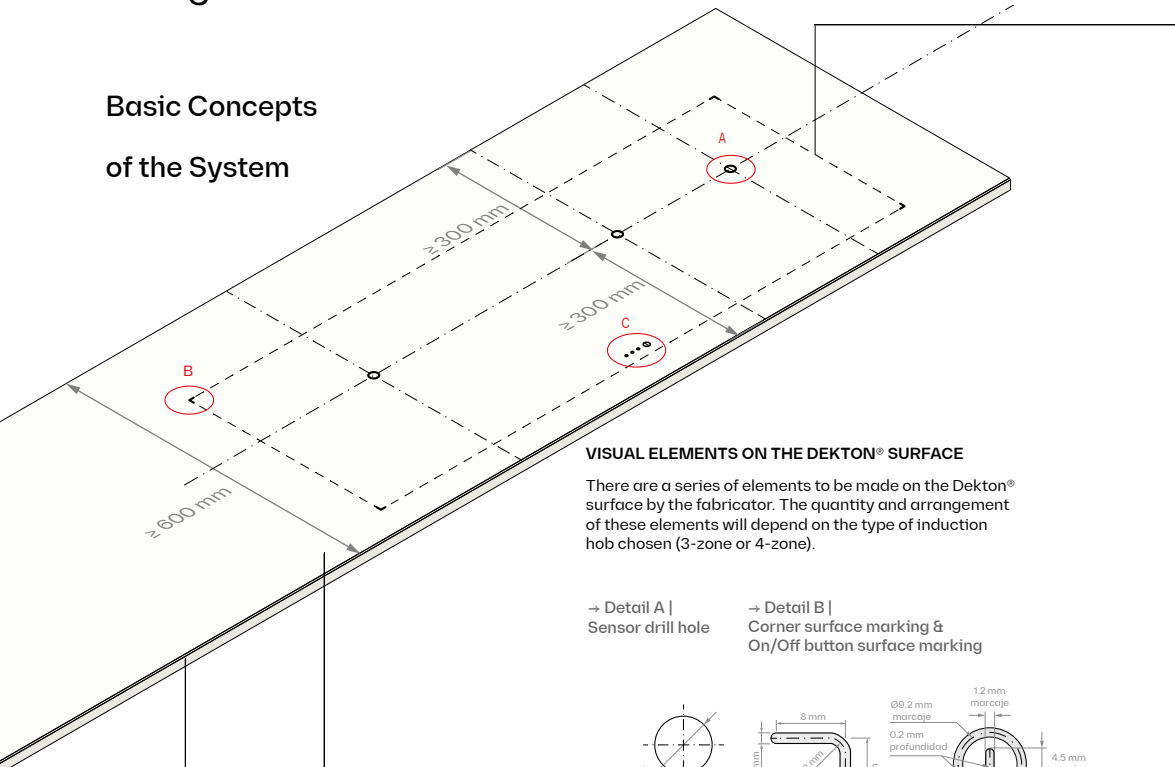

VISUAL ELEMENTS ON THE DEKTON® SURFACE

There are a series of elements to be made on the Dekton® surface by the fabricator. The quantity and arrangement of these elements will depend on the type of induction hob chosen (3-zone or 4-zone).

→ Detail A | Sensor drill hole

→ Detail B | Corner surface marking & On/Off button surface marking

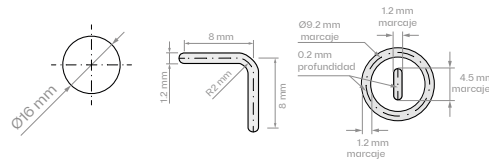

→ Detail C | Three LED's drill holes & On/Off button surface marking

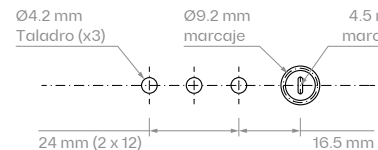

→ Detail D | Four LED's drill holes & On/Off button surface marking

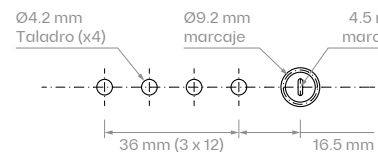

Available colors
Not all Dekton® colors are compatible with the Novy Undercover system. Please refer to this approved [ColorList](#).

Countertop thickness
Although Dekton® is available in different thicknesses, the Novy Undercover induction hob can only be used with 20 mm thickness (without mesh).

- X 4 mm
- X 8 mm
- X 12 mm
- ✓ 20 mm

Available Novy Undercover induction hobs

Depending on the type of unit chosen, which will be installed under the Dekton® surface, the characteristics, visual elements (through drill hole and surface markings), and dimensions that will influence the design of the countertop are:

→ 3-Zone Induction hob (Novy 53006)

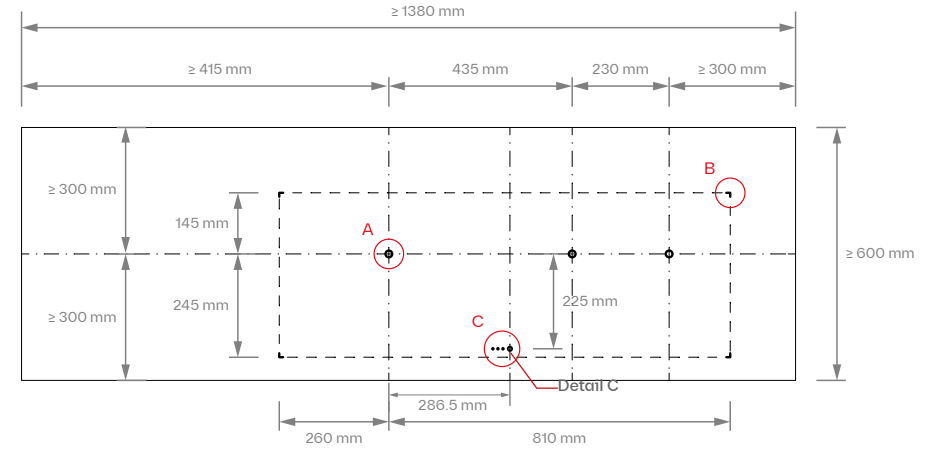

→ 4-Zone Induction hob (Novy 53007)

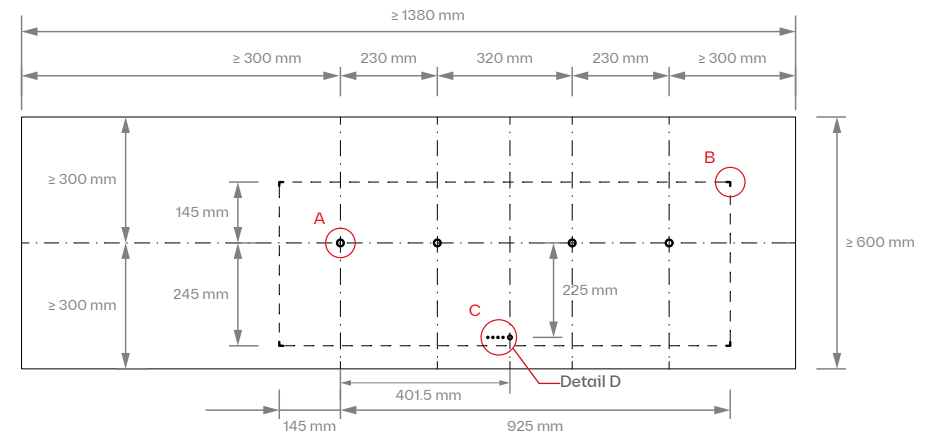

→ Please refer to the [NOVY fabrication guide](#) published by Cosentino® for drilling and surface marking for Novy Undercover, where you will find all the necessary information: dimensions, depth, tolerances, fabrication parameters, approved tools, etc.

Panoramic Configuration

The integrated induction modules must always be placed with their long side completely in parallel to the longitudinal axis of the countertop/ island.

Configuration cabinets in 120 cm

✓ → For the 120 cm long configuration, a supportbar is recommended to provide stability to the furniture.

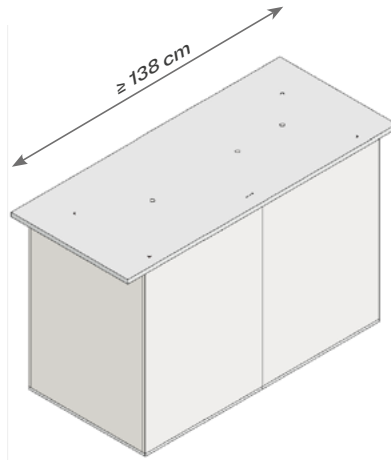
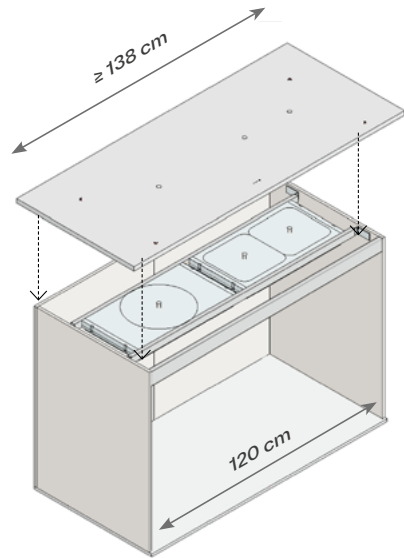

→ The Novy® system rests on the cabinet, but the cabinet **should not be considered a support** for the countertop.

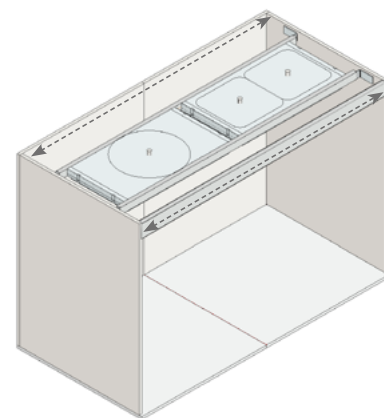
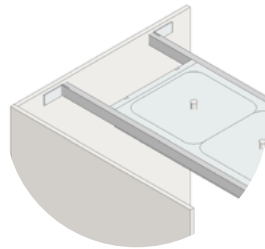

→ To adjust the Novy system, the telescopic supports can be adjusted and extended to fit the size of the furniture, with a maximum extension of 3 cm to fit the different thicknesses of furniture.

Depth/Hang

Induction modules must be placed under the countertop, always attached to the cabinet and never to the countertop. For more details on the clearance required under the induction hob, please refer to the manual provided by the manufacturer on the website www.novy.com.

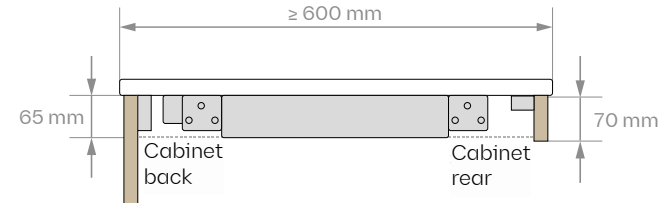

Color code for system operation



The lighting of the cooking area will present the following colors, which will indicate the process in which the induction system is and the degree of caution to be taken when touching the Dekton® surface:

→ Lights on

→ 50% white

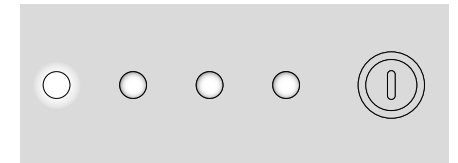

The hob is turned on, one zone is active.

→ Lights Off

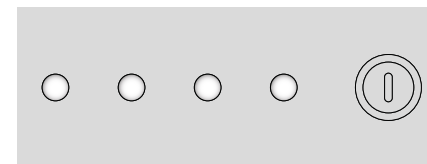

The system is turned off.

→ 1 LED solid red, the rest off

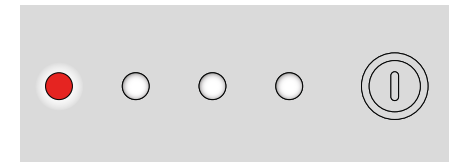

The hob is turned off, but one zone is still hot.

Installation Criteria

Supports and reinforcements

Support

It is the part of the cabinet that supports the countertop, transmits loads, and keeps it immobile and stable.

The countertop must always rest completely on the three sides of the cabinet, which must be made of a material that is strong enough to withstand the stress and keep the countertop level.

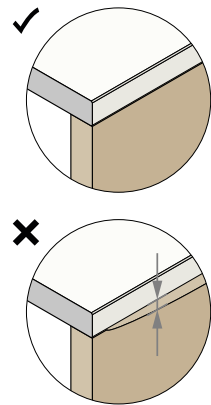

→ To install the Novy Undercover, embed the pre-assembled structure into the cabinet using **4 adjustable L-shaped brackets** that must be secured with screws.

DISTANCES BETWEEN SUPPORTS

When designing the kitchen countertop/island, it is important to bear in mind that the position of the supports and the induction hob will be closely related and will influence each other. Therefore, it is essential to carefully plan the location of both elements to ensure an optimal and functional result.

Due to the installation characteristics of this system, which you can consult in the manufacturer's documentation, the free distance between supports for installing the Novy Undercover induction hob is 1,200 mm.

Joint supports

It is recommended to place the joints directly above a cabinet support.

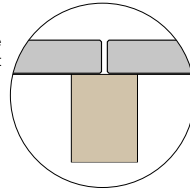

Cabinet Support Bars

Install a support bar flush with the side supports of the cabinet, 7 cm high. Ventilation will be provided from below to facilitate ventilation of the induction hobs and contribute to the stability of the cabinet.

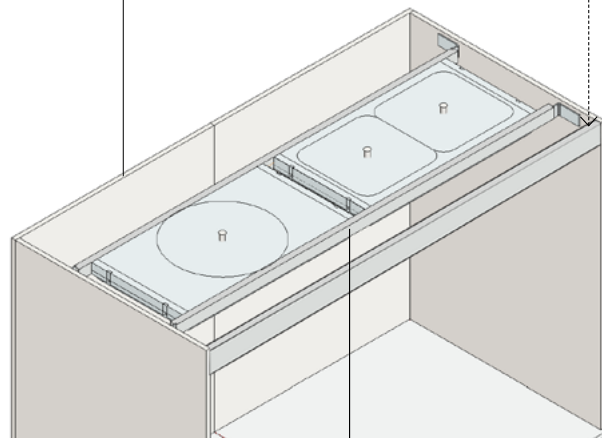
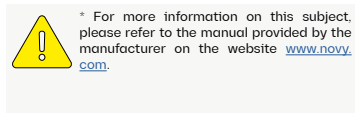

NOVY Support Bars

To install the Novy system, install the included support bars directly under the countertop (anchored to the sides of the cabinet) so that the induction hobs are flush with the countertop without putting pressure on it or hanging from it.

Recommended edges

Unexposed edges

These are the ones that go against vertical surfaces, at the joints of the countertop...

It is not necessary to polish the edge. Simply "round off" the edges, both lower and upper.

→ Unpolished straight

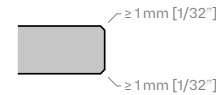

Exposed edges

Use one of the following types on countertops/islands to improve the performance of exposed edges.

→ Flat edge

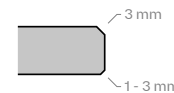

→ 1/2 bullnose

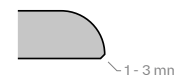

→ Shark nose

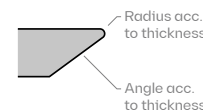

→ Mitred apron edge

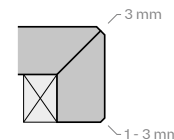

→ 1/4 bullnose

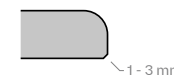

→ Bullnose

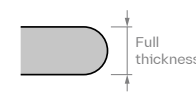

→ Dovetail

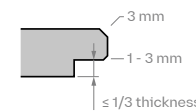

→ Double flat edge

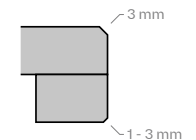

→ Mitre cut
Maximum hem length of 9 cm

→ Straight edge

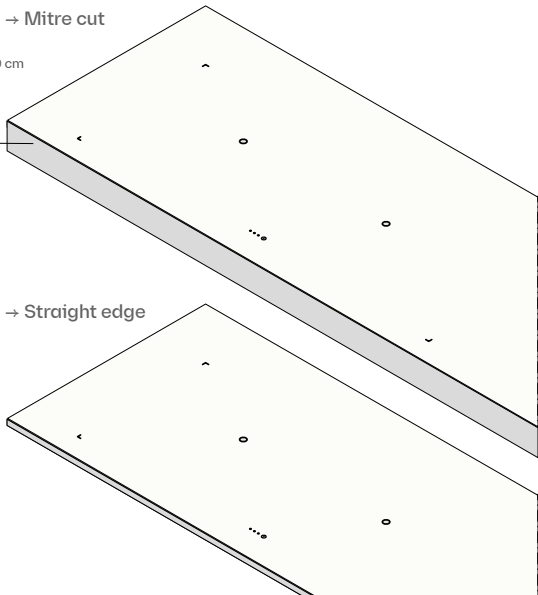

edge recommendation according to thickness

	20 mm
Flat edge	●
1/4 bullnose ⁽²⁾	●
1/2 bullnose	●
Bullnose ⁽²⁾	●
Shark nose	●
Dovetail ⁽²⁾	●
Mitred apron edge ⁽²⁾	●
Double flat edge	●

→ (●) Recommended; (●) Accepted; → (2) Valid only for straight sections.

Fittings:
Sink and tap

LEFT SIDE
→ 3-Zone Induction hob (Novy 53006)

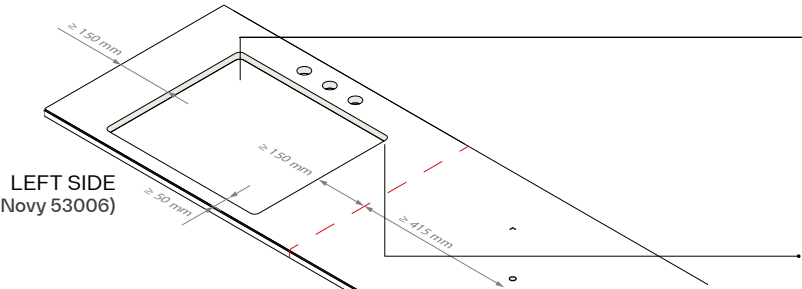

LEFT SIDE
→ 4-Zone Induction hob (Novy 53007)

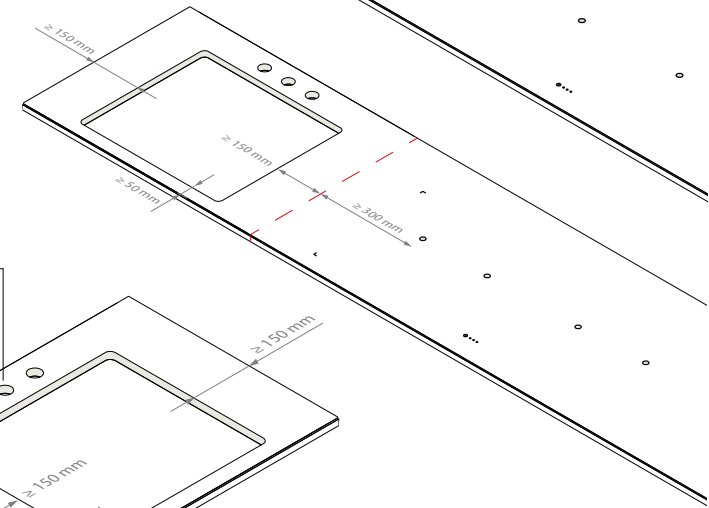

RIGHT SIDE
→ 3-Zone Induction hob (Novy 53006)
→ 4-Zone Induction hob (Novy 53007)

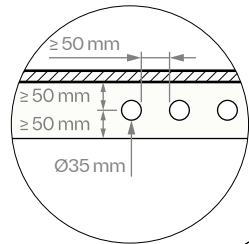

Sink Installation

→ For more information on the correct installation of undermount sinks and the recommended distance from the Dekton splashback, see the [Dekton Countertop Design and Installation Manual](#).

Minimum radius (sinks)

Ensure that the inside corners have a minimum radius of 10 mm [3/8"] when making the cut-out.

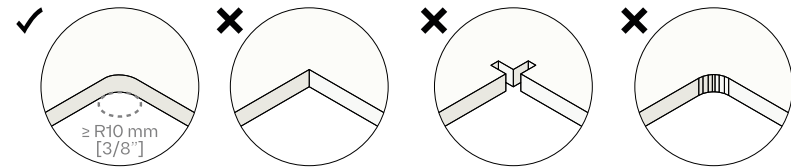

OTHER CUT-OUTS

Instead of a sink, other types of cutouts with various uses may be required: a space for trash disposal, electrical outlets for other appliances, etc. In this case, in addition to complying with all the points mentioned above (separating joint, distances, etc.), there are two types of cutouts depending on their intended use:

→ Sockets

Continuous straight cut with water supply.

→ Electrical Outlets

Drill overlapping holes with a Ø68 mm drill bit. Drill holes until the required size is reached.

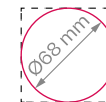
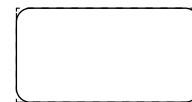

A flexible joint is NOT mandatory for zone separation, EXCEPTIONS APPLY. This [FAQ](#) forms part of the technical documentation and must be fully complied with.

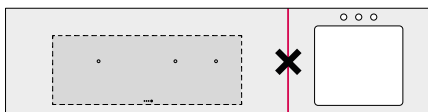

→ For any type of cut-out or drill hole, it is recommended to slightly bevel both the upper and lower edges.
→ If there are overhangs on the countertop, refer to the minimum distances established in the corresponding section.

Island overhangs:
Area with induction hobs

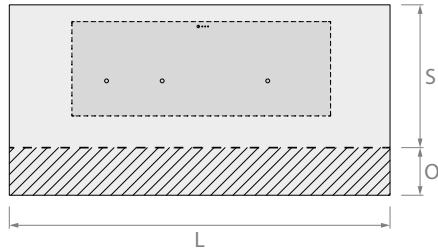

1. Long side overhang

	20 mm
O	≤ 400 mm
S	≥ 600 mm
L	≥ 1380 mm

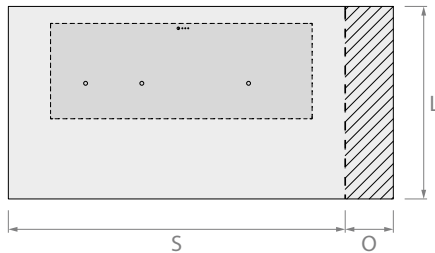

2. Short side overhang

	20 mm
O	≤ 400 mm
S	≥ 1380 mm
L	≥ 600 mm

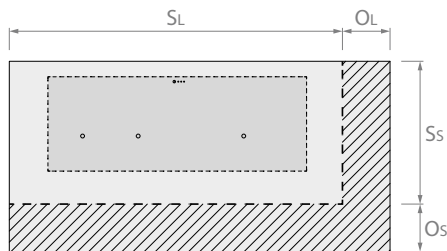

3. L-shaped overhang

	20 mm
oL	≤ 400 mm
sL	≥ 1380 mm
os	≤ 400 mm
ss	≥ 800 mm

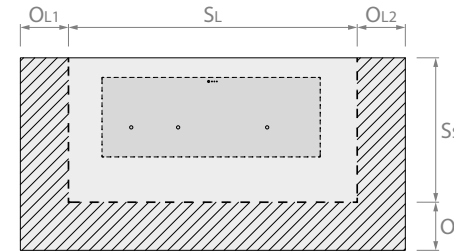

4. U-shaped overhang

	20 mm
OL1, L2	≤ 400 mm
sL	≥ 1380 mm
os	≤ 400 mm
ss	≥ 800 mm

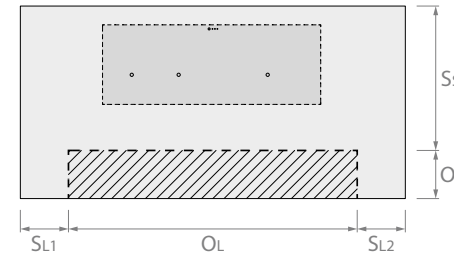

5. Partial overhang

	20 mm
OL	≤ 1,500 mm
SL1, L2*	≥ 100 mm
os	≤ 400 mm
ss	≥ 600 mm

→ (*) Below these values, it is considered to be "1. Overhang on long side"

→ (O) Overhang; (S) Support; (L) Overhang length; (oL) Long side overhang; (os) Short side overhang; (eN) Long side support; (ss) Short side support.

→ Maximum concentrated static load = 100 kg [220 lb].



→ The values established above are valid only for the 20 mm Dekton countertop without sink cut-outs.

→ Where the countertop includes any cut-outs, the general guidelines established in the [Dekton Countertop Design and Installation Manual](#) shall be followed.

Waterfall edges

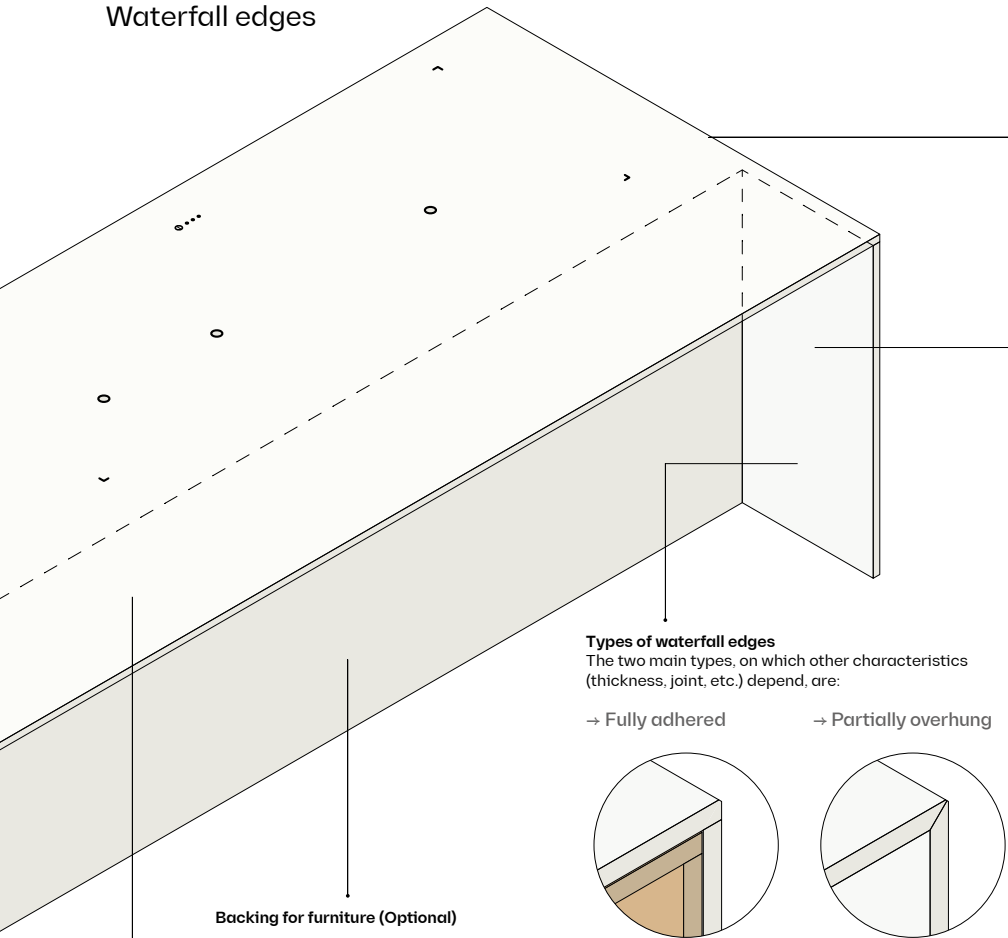

Types of waterfall edges
The two main types, on which other characteristics (thickness, joint, etc.) depend, are:

- Fully adhered
- Partially overhung

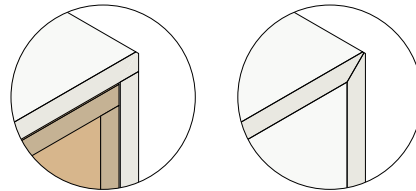

Backing for furniture (Optional)

Follow the same recommendations given for the edges of the waterfall: thicknesses, joints, gluing, etc.

Side waterfall + Overhang

If the use of waterfall edges in combination with island overhangs is required, the maximum dimensions of both elements would be:

1. Waterfall edges with partial overhang: ≤ 250 mm.
2. Fully adhered waterfall edges (cabinet cladding): Dimensions set out in the section 'Island overhangs'.

Recommended thicknesses

	Fully adhered to cabinet	Partially overhung
4 mm	●	●
8 mm	●	●
12 mm	●	●
20 mm	●	●

→ (●) Recommended; (●) Accepted; (●) Not recommended.

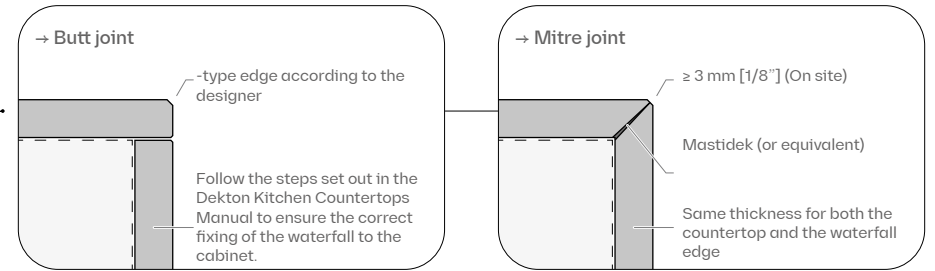

Interior finish of the side waterfall

In the case of waterfall edges where the rough back face of Dekton® is exposed, and depending on the required design and the characteristics of the waterfall edge, there are three ways to achieve a better look for that area:

- Back side sanding
- Dekton® return
- Dekton® return (over cabinet)

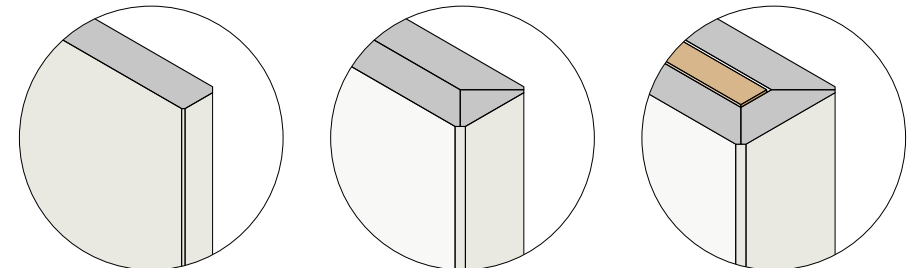

- NEVER similar to the front face of the waterfall edge.
- Thickness: 12 and 20 mm.
- Preparation: Sanding sequence (GR50 - GR100 - GR200 - GR400).
- Valid only for partially overhung waterfalls.

- Just like on the front face of the waterfall edge.
- Thickness: 12 and 20 mm.
- Fabrication: Gluing mitered pieces together
- Valid only for partially overhung waterfalls.

- Just like on the front face of the waterfall edge.
- Thickness: 4, 8, 12, and 20 mm.
- Fabrication: Gluing mitered pieces to the cabinet structure.
- Valid only for waterfalls that are fully adhered to the furniture.



→ For this application, Dekton® will NEVER have a structural function. It will only act as a covering for the cabinet, which will bear the load.

→ When using a thickness different from that of the countertop (only for cabinets fully adhered to waterfall edges), take into account both the pattern and the tone when designing and installing.

→ The top surface must always be 20 mm thick; only the sides may have a different thickness.

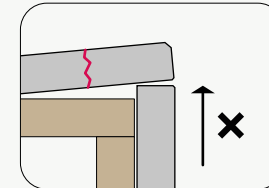

→ The waterfall edge MUST NOT lift the countertop off the cabinet.
The countertop must always rest on top of the cabinet structure.

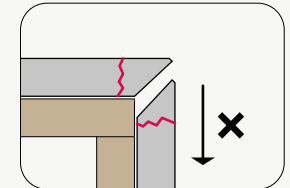

→ If the waterfall edge comes loose, the joint with the countertop will break and open up.
To avoid this, the waterfall edge must fit properly to the cabinet.

Other considerations

→ Use of the system indoors only

Novy Undercover is only approved for use on Dekton® surfaces installed indoors. Under no circumstances should this system be installed on outdoor countertops.

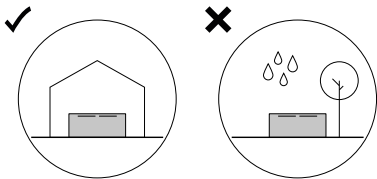

→ Indoor use.

→ External use.

→ Traditional installation

The countertop can be installed parallel to the wall, maintaining a minimum gap of 3 mm on the long side.

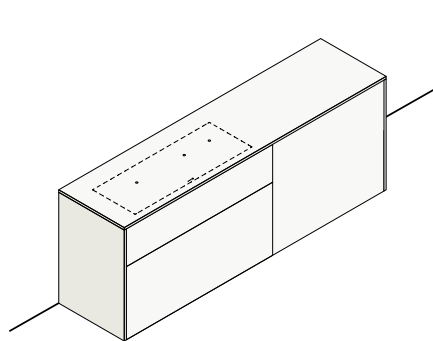

→ Island installation

The island design can be placed in any space in the kitchen, provided that the guidelines set out in this manual are followed.

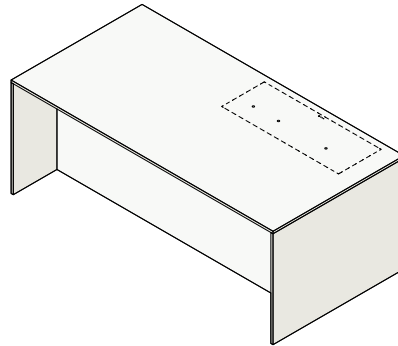

→ Installation on the peninsula

The peninsula can be installed perpendicular to the wall, maintaining a minimum gap of 3 mm on the short side.

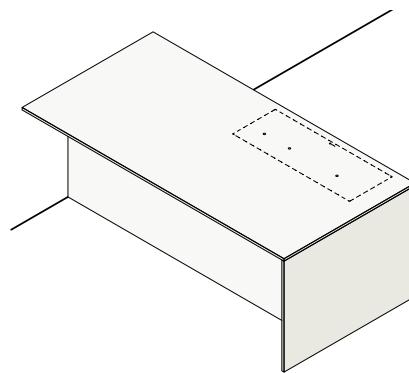

Slab formats

Depending on the color and thickness, Dekton® is available in two different slab formats. Therefore, it is necessary to consult* the original dimensions when designing on our material.

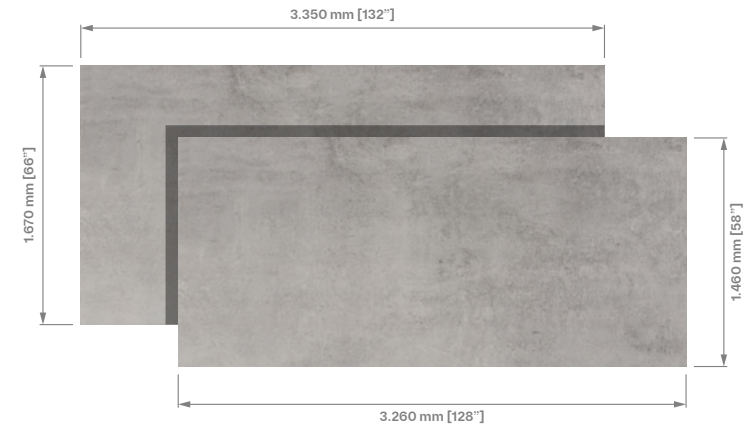

→ (*) Consult your nearest Cosentino® contact person.

→ Patterns and use of multiple slabs

Given that Dekton® patterns have been designed for large formats (full slabs), it is possible that in smaller formats used for islands/peninsulas, color tone variations, certain contrasts, or changes in orientation between pieces may be observed, either for design reasons (islands + waterfall edges) or due to dimensions (when more than one slab is required).

Therefore, it is advisable to take this into account from the design phase through to manufacturing.

Below is an example of how the cutting pattern influences the final result of a piece:

Option A
Grain parallel to the cut pattern.

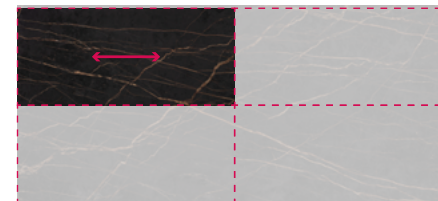

Option B
Grain perpendicular to the cut pattern.

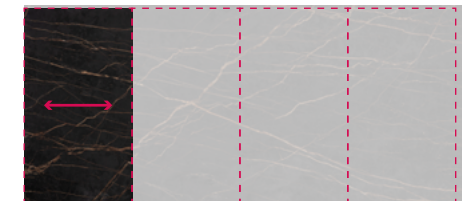

Differences in the orientation of the veins depending on the selected cutting pattern.

Installation process and recommendations

1. Before you begin

Protect anything that could be stained or damaged, and check that the support area is clean and free of objects.

2. Dimensions

Check the dimensions of the cabinet and the cut countertop parts.

3. Cabinet

Check that the cabinet is correctly leveled. Correct, if necessary, appropriately and according to the type of cabinet chosen.

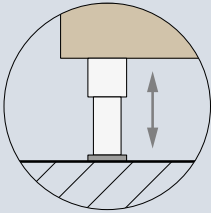

4. Placement

Place the countertop parts on the cabinets once they are level and adjust their position. Check that the countertop is fully supported with a gauge.

5. Installing the Sink

Installation will be carried out according to the type of induction selected. When installing large sinks (> 600 mm) or particularly heavy sinks, install support bars directly underneath, anchored to the cabinets, to support the weight.

11. Supports and reinforcements

Check that the distances and recommendations set out for 20 mm thick Dekton® are observed.

6. Leveling the top

Ensure that the top of the cabinet is completely level, as the countertop must rest completely on the cabinet structure.

7. Joint between parts

In the case that a flexible joint is needed, it is recommended using leveling suction cups and the recommended adhesive (Colordek or silicone in the same color as the countertop) is recommended. Use masking tape to protect the surface.

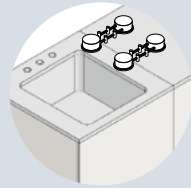

8. Integrated induction hobs

Install the hobs according to the manufacturer's recommendations (on the website www.novy.com).

IMPORTANT: It is necessary to leave sufficient space under the countertop to be able to operate comfortably during the installation of the modules, as well as for possible maintenance work on them.

9. Adhesive

Apply the appropriate adhesive to the top edges of the cabinets or reinforcements, taking care not to stain the rest of the unit.

10. Final cleaning

It is important to carry out a final clean-up of the site as soon as possible to remove any residue from the installation process.

We recommend using Cosentino Q-Action® SKU | 91191

GAP BETWEEN COUNTERTOP AND WALL

If installing a peninsula instead of an island, place the countertop pieces on the cabinets once they have been leveled and adjusted, leaving a perimeter joint of at least 3 mm in all areas of contact with the vertical wall, and fill the visible areas with silicone.

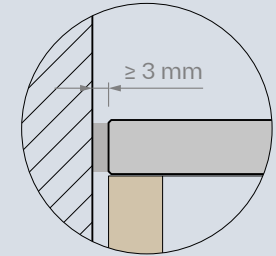

SPLASHBACK* (FOR COUNTERTOPS & PENINSULAS)

- Position the front and adjust if necessary.
- Apply the recommended adhesive/putty to ensure a rigid bond and stick the piece to the support, which will bear the entire load of the splashback.

→ (*) For bonding splashbacks, follow the recommendations in the [Dekton® Quick Guide to Interior Wall Coverings](#). To glue frames, simply apply silicone beads.

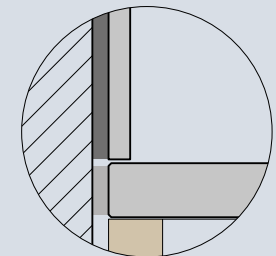

WATERFALL EDGES (OPTIONAL)

Install the waterfall edge by gluing it to the cabinet according to the type of joint chosen (butt/mitre) and using adhesives/fillers that ensure an appropriate bond, so that the waterfall edge does NOT have a structural function.

→ Always use tools and adhesives recommended by Cosentino®.

→ Failure to follow the instructions in this manual correctly may result in damage to the equipment.



→ For any other design or installation aspects not included in this Manual, please refer to the [Dekton® Countertop Design and Installation Manual](#) for Dekton® countertops.

Good practices

System usage

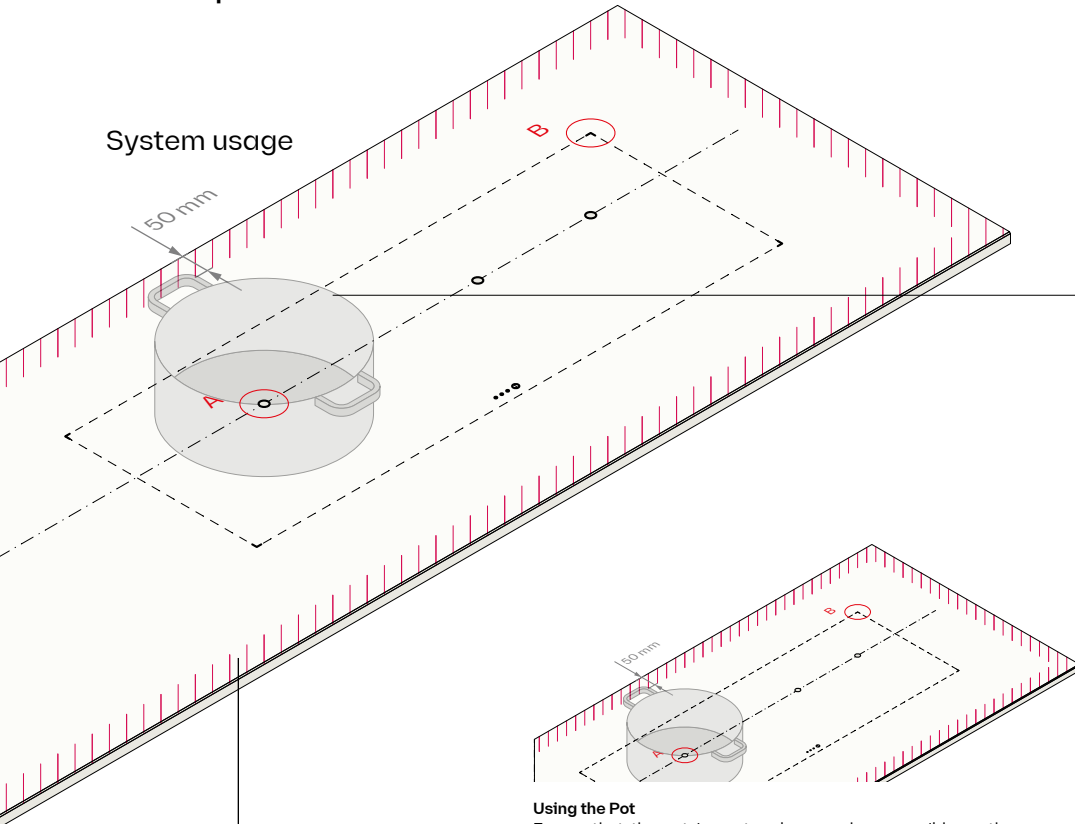

Safety perimeter for cooling/handling

When placing the cooking vessel (frying pan, pot, etc.) on the countertop, whether you have just removed it from the cooking zone or it is already hot, you must leave a 50 mm cold perimeter around any edge of the island: edges, joints, cutouts, etc.

Using the Pot

Ensure that the pot is centered as much as possible on the induction point, as this will ensure optimal performance of the Novy system.

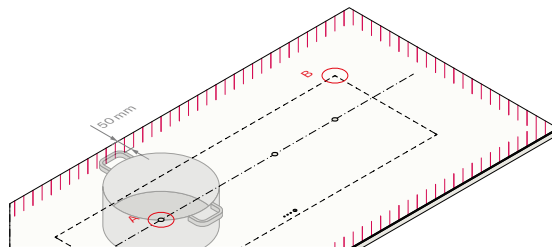

Using the Novy tray

When using this tray, be sure to install Novy's dual induction system and center the tray as much as possible between the two points to ensure optimal performance.

Do not place spacers under the pot.

The integrated induction module system can operate without the need for any additional protection. Place the pot directly on the countertop without sliding it to avoid scratches.

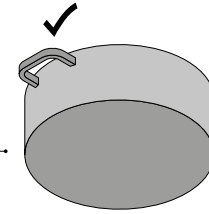

Dimensions of kitchen utensils

For safe and efficient use of the integrated induction system, it is essential to follow the manufacturer's recommendations regarding cookware: type of kitchen utensils, recommended diameter range (depending on the chosen module), etc.

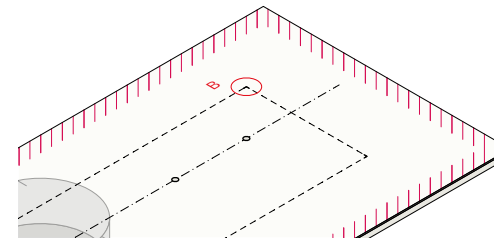
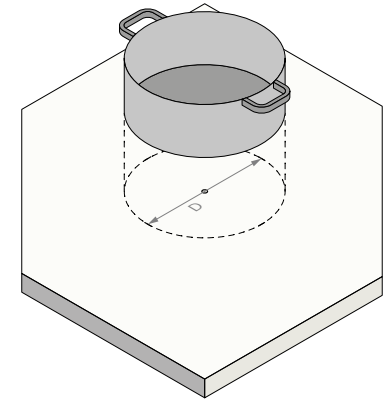

Do not place pots on the edges of the countertop.

Do not place hot pots on the shaded area (5 cm from the edges and joints) to ensure the integrity of the countertop and the safety of users.

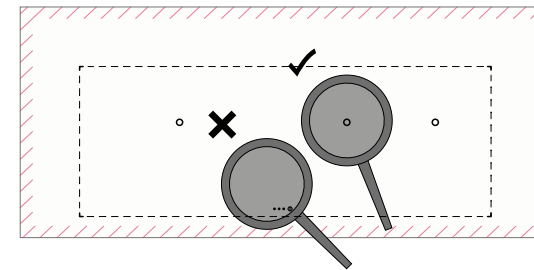

Do not place pots on the control buttons.

Placing pots in this area may cause the system to malfunction.



→ Avoid banging pots and pans against the countertop.

→ Dekton® retains the heat transmitted by hot kitchen utensils and cools slowly. Cooling time may vary depending on the size of the container, the power and cooking time, as well as the ambient temperature and humidity.

→ It is important to note that the information provided is merely indicative, and that it is mandatory to pay attention to and follow the detailed instructions in the induction module manufacturer's manual to ensure safe and efficient use of the modules. Therefore, it is recommended to consult the manual provided by the manufacturer on the website www.Novy.com.

Cleaning and maintenance of

→ Cleaning and regular maintenance

Due to its low porosity, Dekton® is a surface that is highly resistant to stains caused by domestic use.

For cleaning Dekton®, Cosentino® recommends using Q-Action® together with a sponge or soft fiber scouring pad.

If this product (or similar) is not available, the best option is to use water and mild soap.

cleaning stubborn stains

For cleaning stubborn stains that, due to their age or composition, are stuck to the surface and cannot be removed with everyday cleaning techniques, we recommend following the table below, which describes various types of stains and the most suitable cleaning products for removing them.

As acidic cleaning products, acidic products such as can be used, descaling agents... For alkaline products, basic cleaning products, ammonia... For solvents, products such as universal solvent, turpentine (turpentine essence), acetone, alcohol... And as oxidants, products such as hydrogen peroxide or diluted bleach.

Stain	Cleaning product
Coffee, wine	Alkaline detergent, acid
Lime, cement residue, plaster	Acid
Rubber	Degreaser
Candle wax, nail polish, aluminum scratches, silicone residue, ink	Solvent
Fats and oils	Alkaline detergent, degreaser
Ice cream	Alkaline detergent
Liquids and organic waste	Conventional detergent, degreaser
Rust	Hydrochloric acid
Cola, fruit juice	Oxidant



→ For any other aspects not included, please refer to the Dekton® document. [Use and Care](#) document.

Impact resistance

Although Dekton® is a highly resistant surface, impacts should be avoided in areas that are most exposed (corners, edges, bevels, etc.).

Heat resistance

Containers such as frying pans, saucepans, or coffee pots can be placed directly on the surface of the material after use.

Electrical appliances that give off heat may also be installed.

Dekton® is designed to withstand the temperatures of household utensils.

Precautions

→ Avoid direct contact with metal parts of electric grills, cooktops, or ovens that, due to poor installation, touch the material directly.

→ Avoid direct exposure to very high temperatures, such as from chimneys, barbecues, etc.

→ Avoid direct contact with flames.

→ Do not polish the surface.

→ Avoid using metal scouring pads or pads with abrasive particles.

→ Avoid cutting directly on the surface with ceramic knives, as they are materials of similar hardness.

→ Avoid contact with hydrofluoric acid.

→ On textured surfaces, avoid friction with objects of similar hardness to prevent surface degradation (gloss, luster, surface appearance, etc.).

Health & safety

Manufacturers and installers working with Dekton® must comply with all applicable laws and regulations regarding occupational health and safety.

Implement the necessary safety measures at work to comply with local regulations. This **Guide** is not exhaustive or a substitute for the relevant regulations, and is provided for informational purposes only.

Safety measures will depend on the specific conditions of each workplace.

Risks associated with handling and transporting

During the transport and handling of Dekton® materials, risks such as impacts, cuts, musculoskeletal disorders, entrapment, or injuries from projections may occur due to improper handling.

Risks associated with processing and transformation

The manufacturing process may involve risks of cuts, injuries from flying debris, entrapment, and exposure to high noise levels and/or respirable crystalline silica dust.

Before processing the product, consult the Dekton® **Safety Data Sheet** and **Good Practice Guide** available upon request from Cosentino® or at osh.cosentino.com.

COSENTINO®

, km 59 / 04850 Cantoria - Almeria (Spain) / Tel.:
+34 950 444 175
info@cosentino.com / www.cosentino.com



→ These certificates apply to
, Dekton®, and Silestone®.

→ Learn about NSF-certified colors at
through www.nsf.org

PRINT DATE: 09/ 2024